

Perfect 10 Hybrid Displays

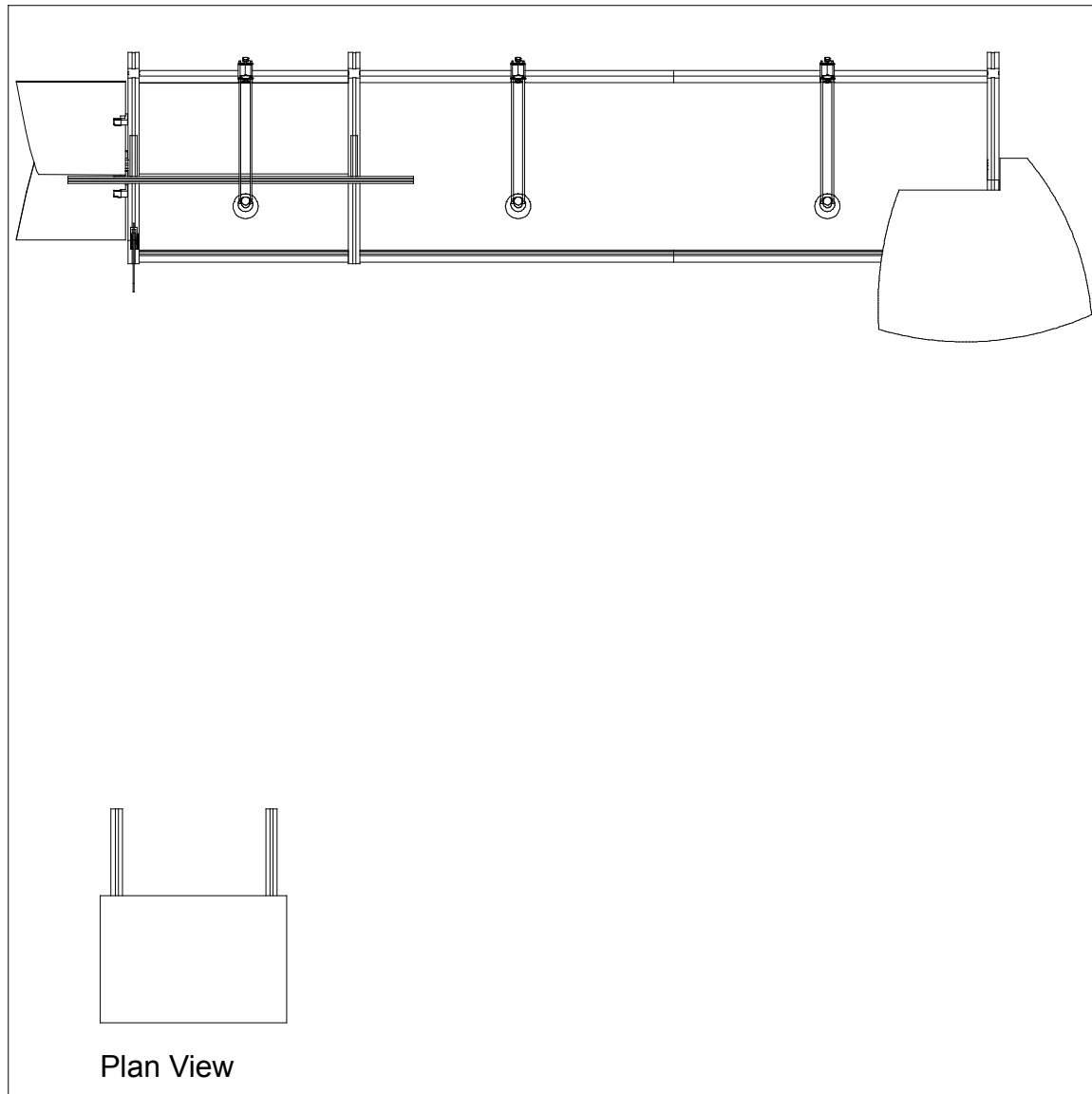

10'

10'

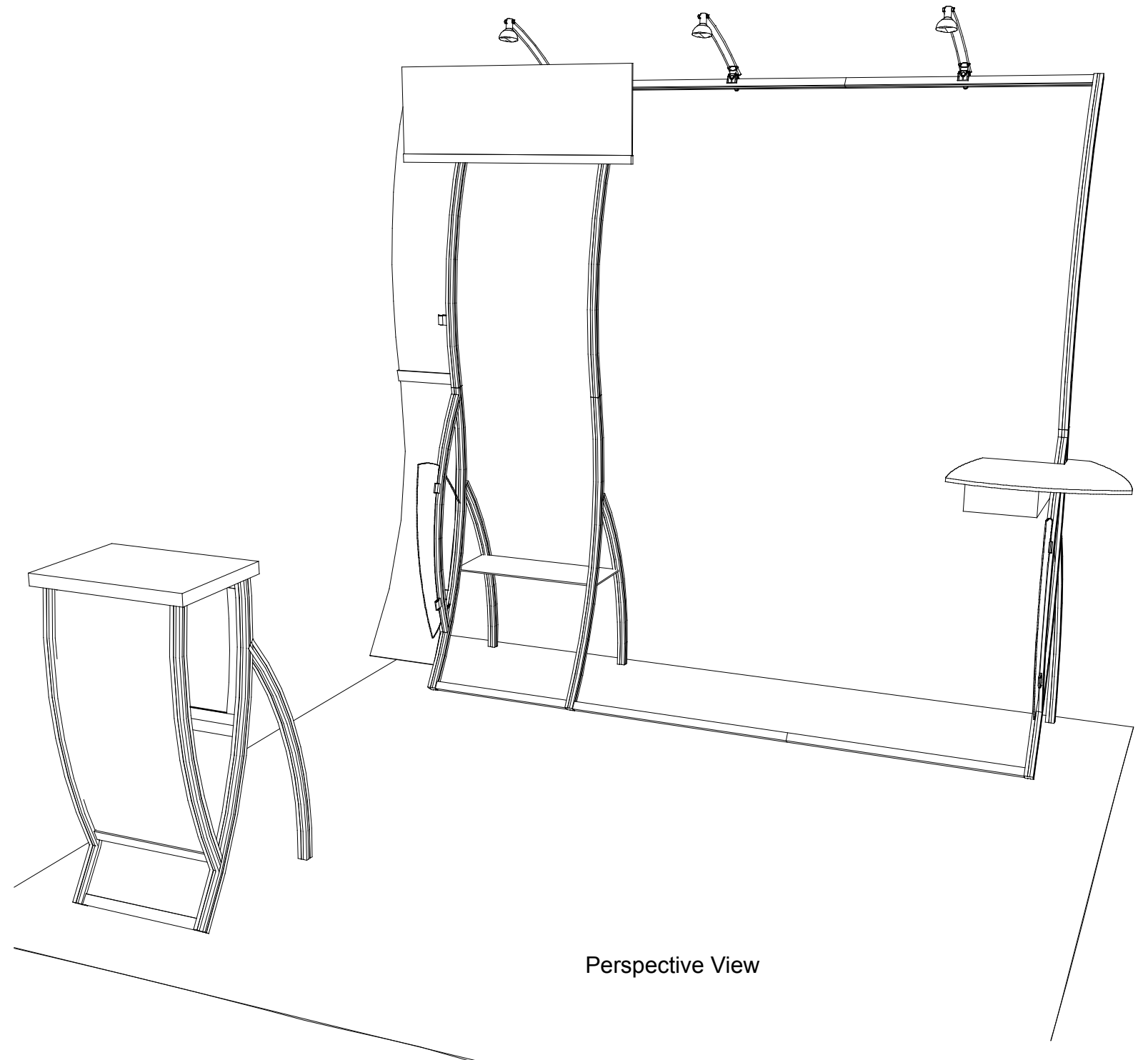

Perspective View

WHEN DISASSEMBLING TIGHTEN ALL KNOBS TO PREVENT LOSS DURING SHIPPING

Item	Qty.	Description
1	1	Left Leg Assembly
2	1	Middle Leg Assembly
3	1	Upper Curved Vertical
3a	1	Upper Curved Vertical
4	2	23" w Horizontal
5	1	Right Leg Assembly
6	1	Upper Curved Vertical
7	1	69" w Horizontal
8	1	69" w Horizontal

Steps:

NOTE: Assembly may be easiest if assembled face down on floor then lifted upright.

- 1) Connect upper curved vertical extrusions [3a,3,6] to leg assemblies [1,2,5].
- 2) Connect lower and upper horizontal extrusions between vertical assemblies by slightly tightening BLACK knobs on backside of extrusion as shown.

NOTE: Make sure velcro faces toward back and knobs face horizontally as shown in detail.

**** Various Accessories Available ****

NOTE: When assembling horizontals they should be placed approximately one inch from TOP and BOTTOM.

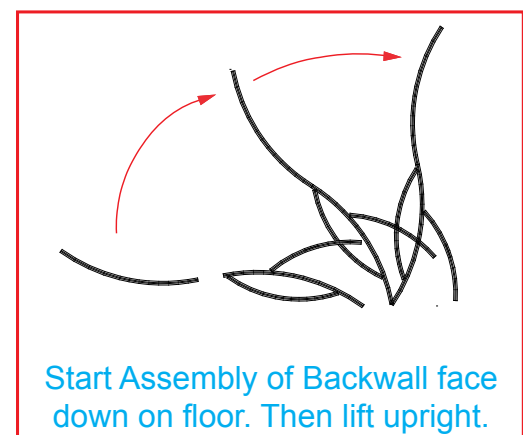
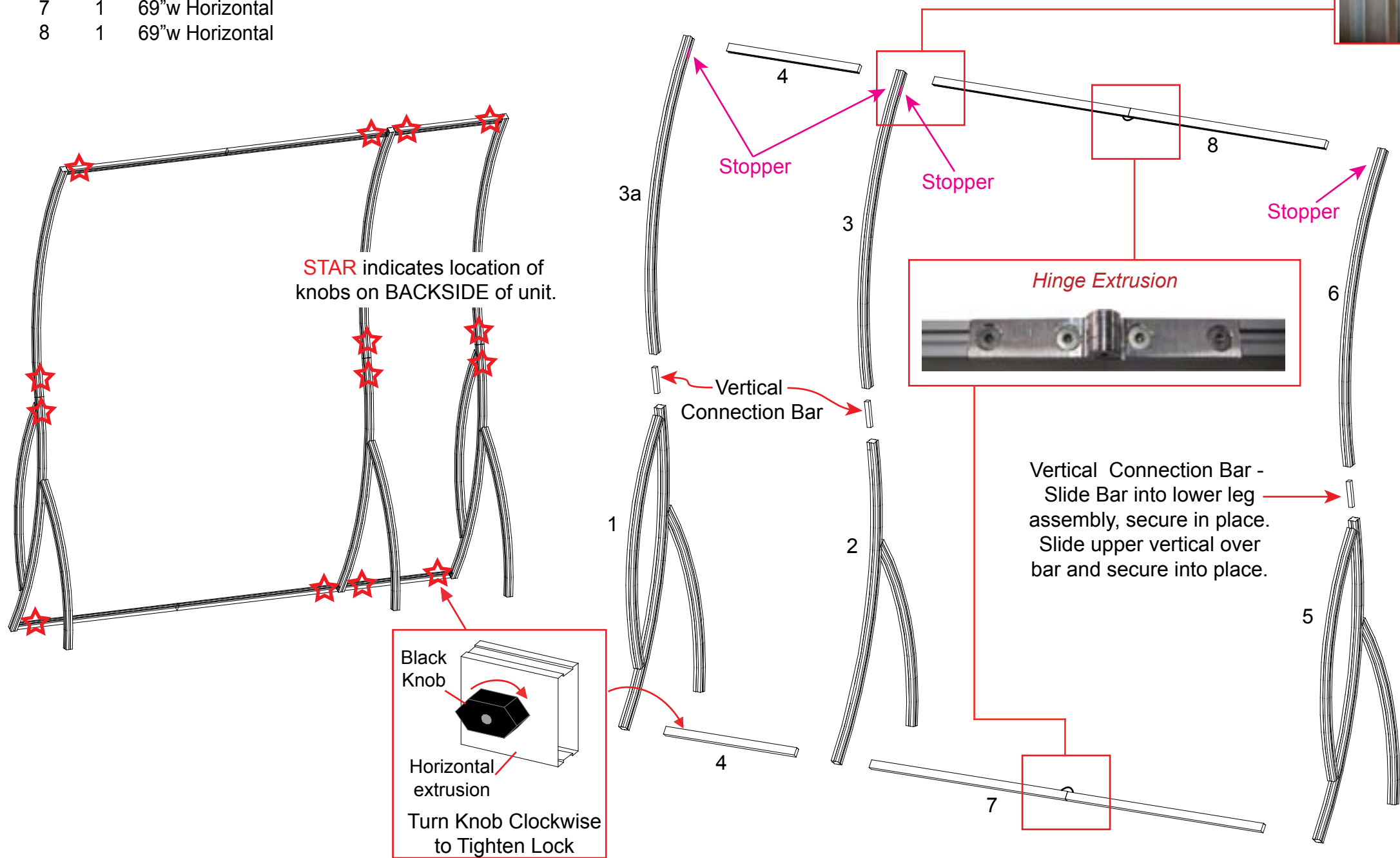

Step stool may be required for assembly.



WHEN DISASSEMBLING TIGHTEN ALL KNOBS TO PREVENT LOSS DURING SHIPPING

866.652.2100

Decorative Blade Attachment (if accidentally removed)
Slide A10 Clamp into groove of square extrusion.

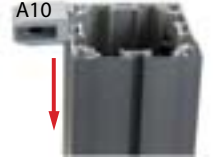

A10

When desired location is found, tighten set screw to secure.



Set-Screw

Tighten plastic knob to secure Wing in place.



Knob

Attach decorative wing and blades to A10's attached to Backwall as shown.



Hex Key Tool
Flathead Screwdriver



(if necessary)

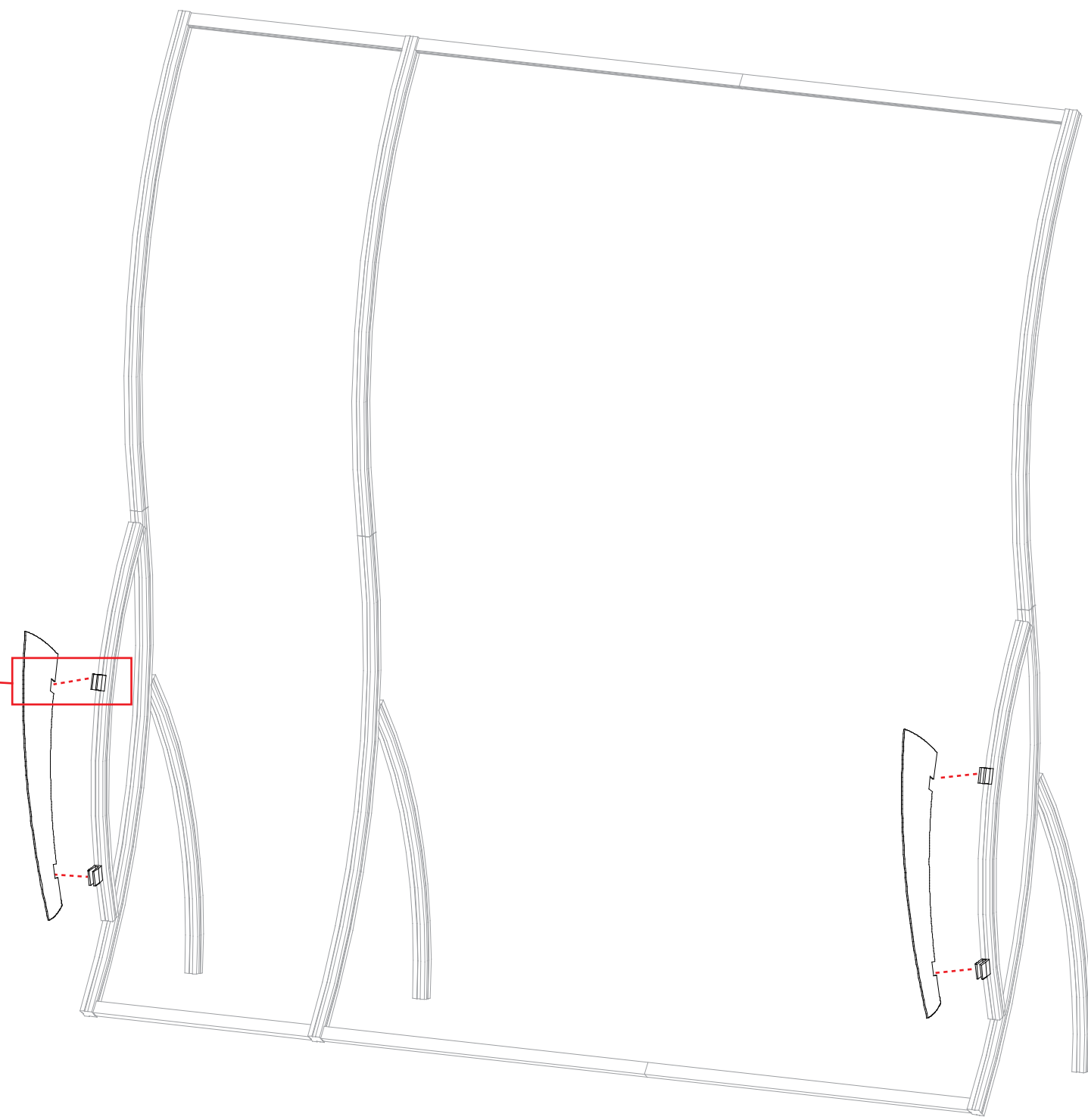

WHEN DISASSEMBLING TIGHTEN ALL KNOBS TO PREVENT LOSS DURING SHIPPING

866.652.2100

Accessory Attachment
Attach header support to backwall and then slide header into groove.

Header

Example of A10 Clamp Attachment

Slide connector on back of A10 clamp into groove of extrusion.

When desired location is found, tighten set screw to secure.

Tighten knob to secure shelf/wing in place.

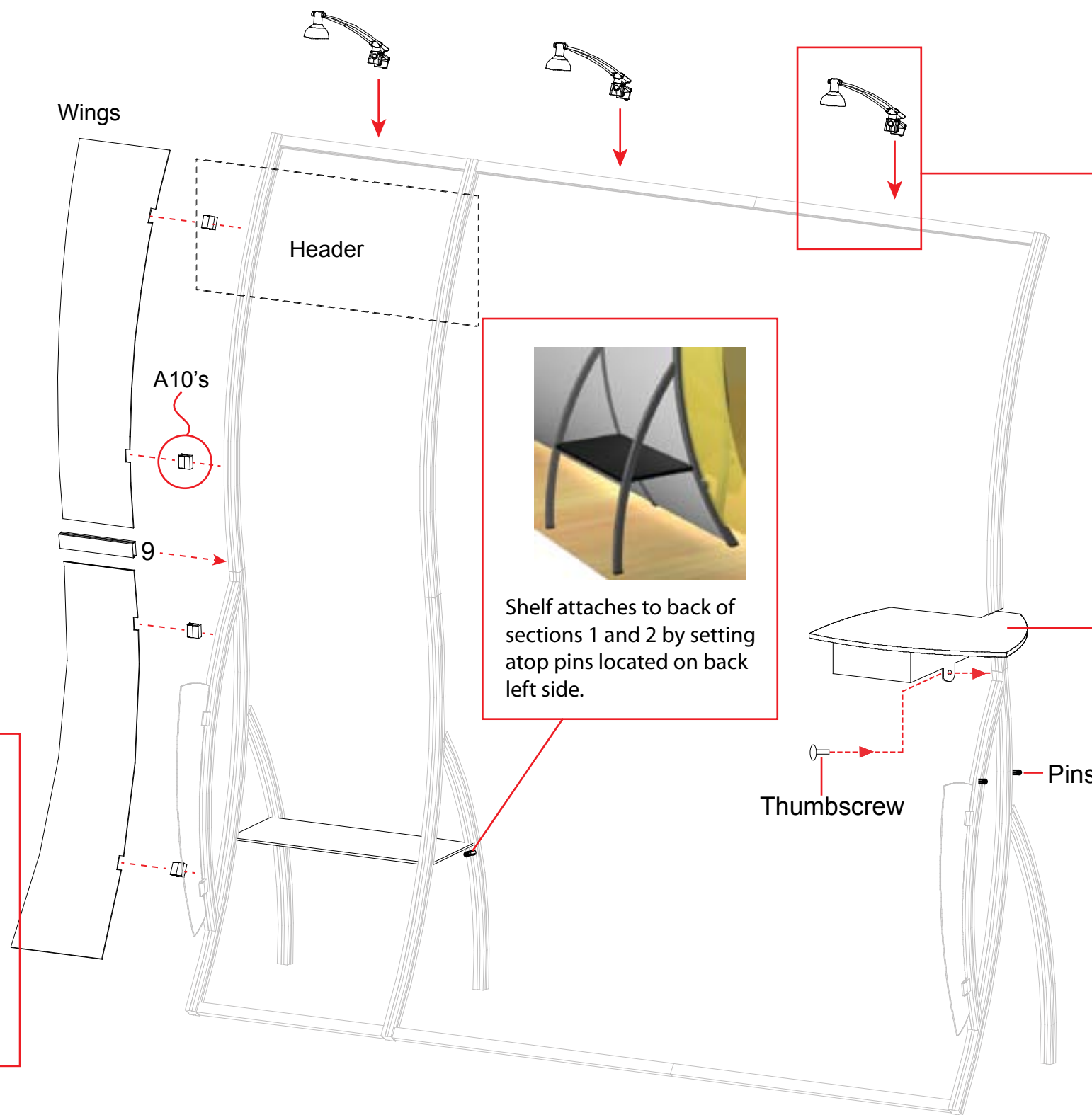

Light Connection

Attach lights to backwall where desired and tighten in place.

Cubby Attachment

Shelf attaches to section 5 by setting atop pins located on right side and securing into place with thumbscrew on left.

Counter Attachment

Slide onto back pin first.

When attaching counter you will need to first slide shelf onto back pin then set down on front pin.

WHEN DISASSEMBLING TIGHTEN ALL KNOBS TO PREVENT LOSS DURING SHIPPING

866.652.2100

Part Number	Description
A	Left Leg Assembly
B	Right Leg Assembly
C	Horizontal Extrusion
D	Horizontal Extrusion w/ Door Stopper

Steps:

- 1) Connect lower horizontal extrusion [C] between bottom of leg assemblies [A and B] as shown.
- 2) Insert Laminated infill into grooves of leg assemblies [A and B].
- 3) Attach extrusion door between leg assemblies [A and B] and on top of laminated infill.
- 4) Attach upper horizontal extrusion w/ door stopper [D] between leg assemblies [A and B], and set flush with top of legs [A and B].

NOTE: Make sure the lock is flush with extrusion before tightening. If lock will not fully engage, gently rock lock and extrusion back and forth while turning knob until lock fully opens.

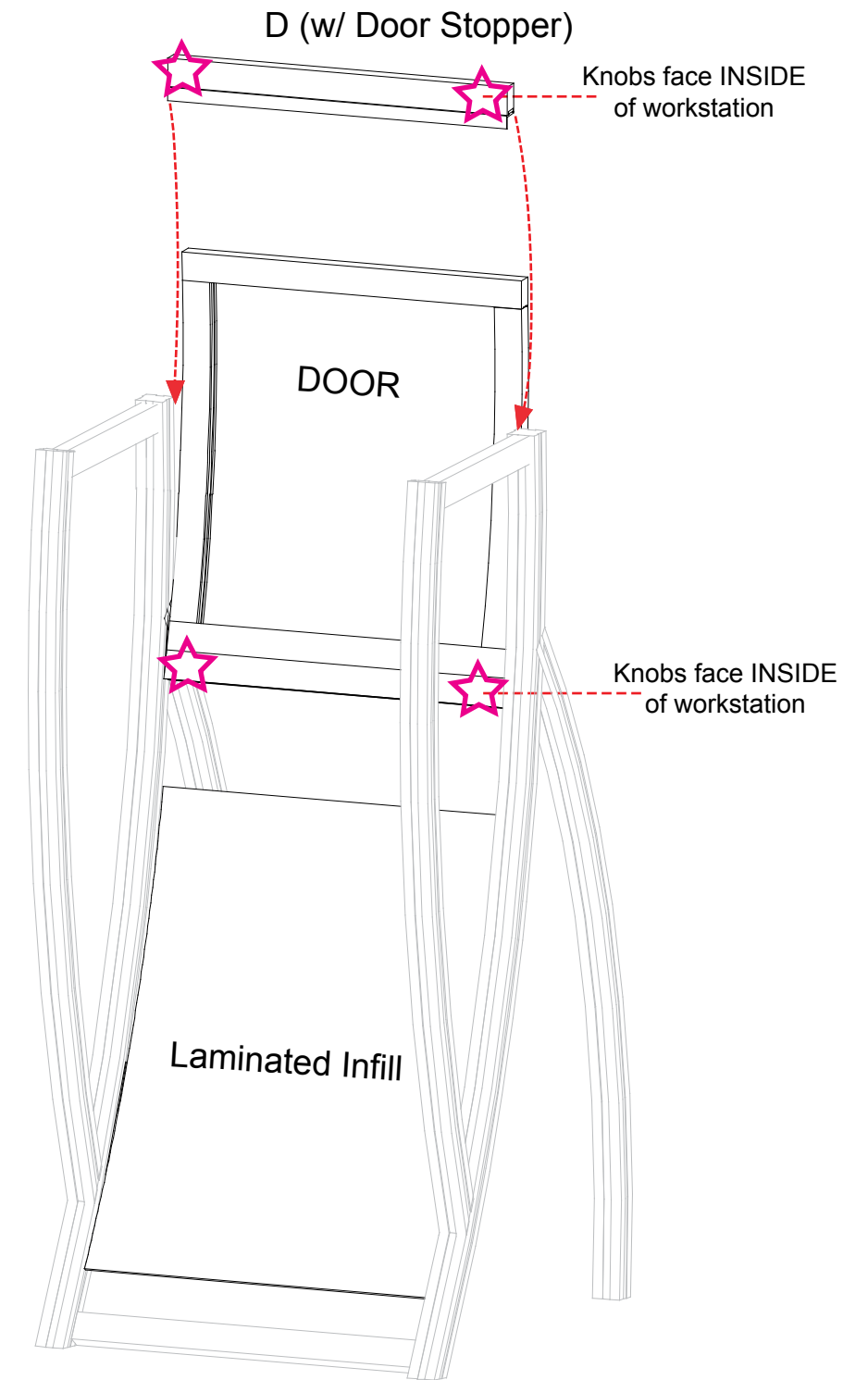
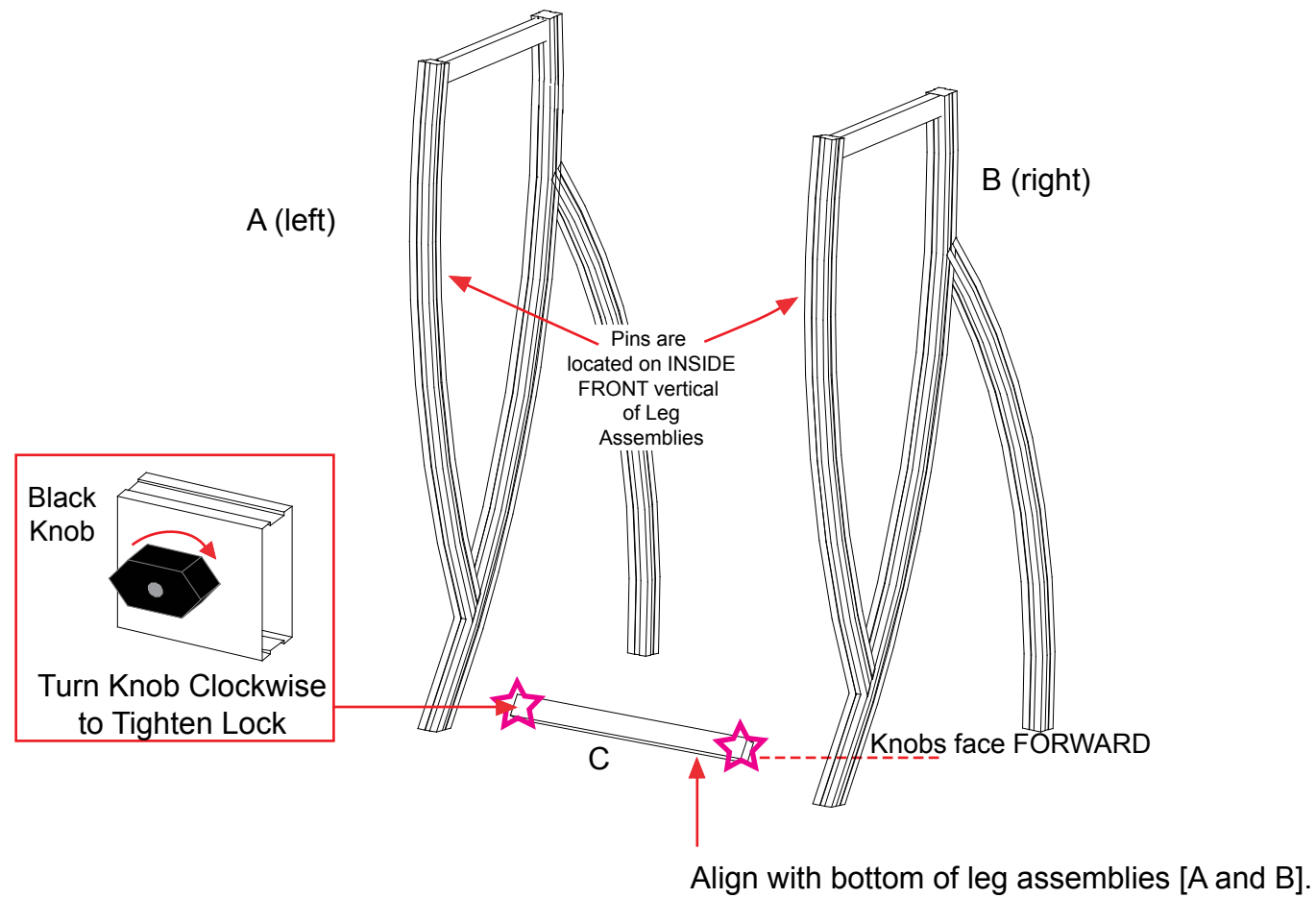

WHEN DISASSEMBLING TIGHTEN ALL KNOBS TO PREVENT LOSS DURING SHIPPING

866.652.2100

Part Number	Description
E	Horizontal Extrusion
F	Horizontal Extrusion

Steps:

- 1) Attach horizontal extrusion [E] between vertical leg assemblies [A and B] as shown below.
- 2) Insert Laminated infill into grooves of vertical leg assemblies [A and B].
- 3) Attach upper horizontal extrusion [F] between vertical leg assemblies [A and B] atop infill.
- 4) Place internal shelf into assembled pedestal atop pins..
- 5) Set Counter atop assembled pedestal and secure with Velcro straps attached to underside of top.

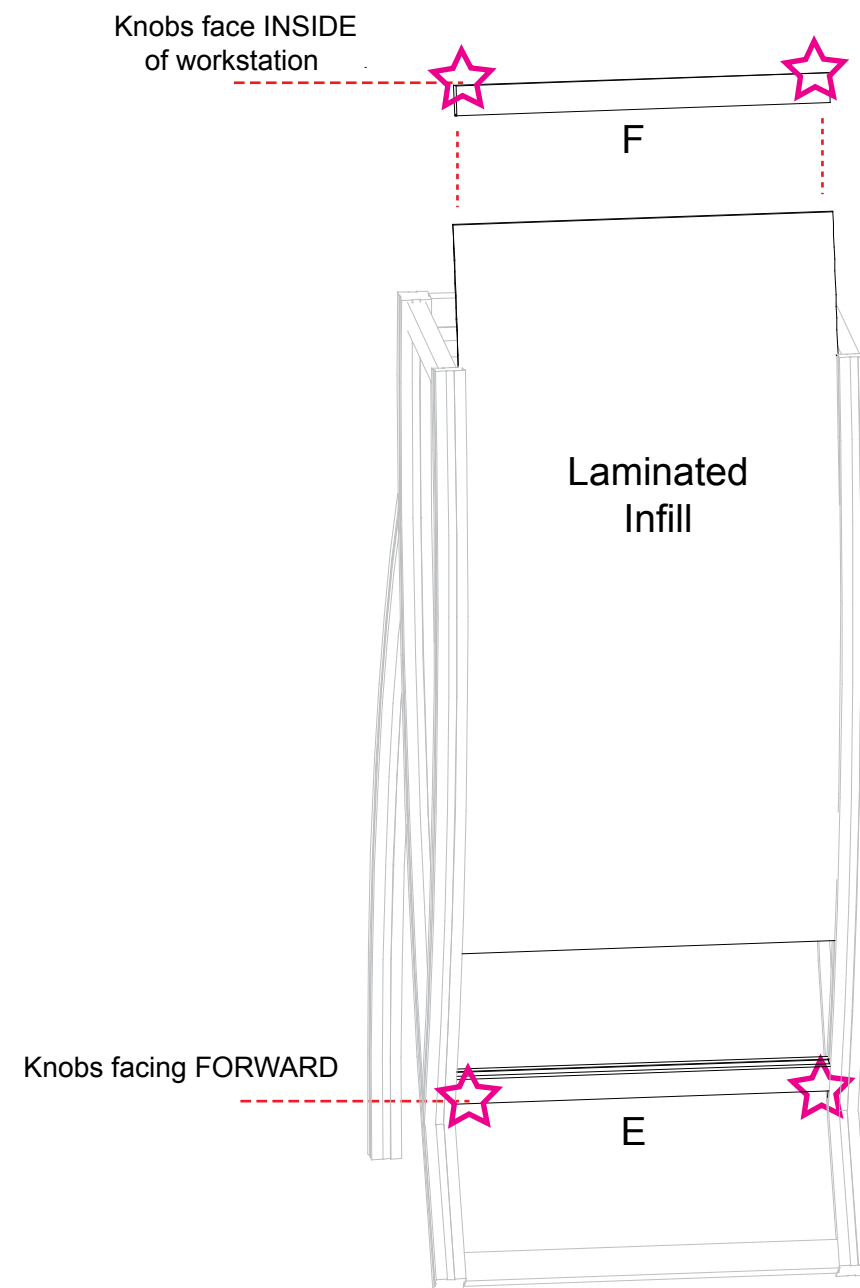

Place internal shelf into workstation then place counter atop assembled workstation.

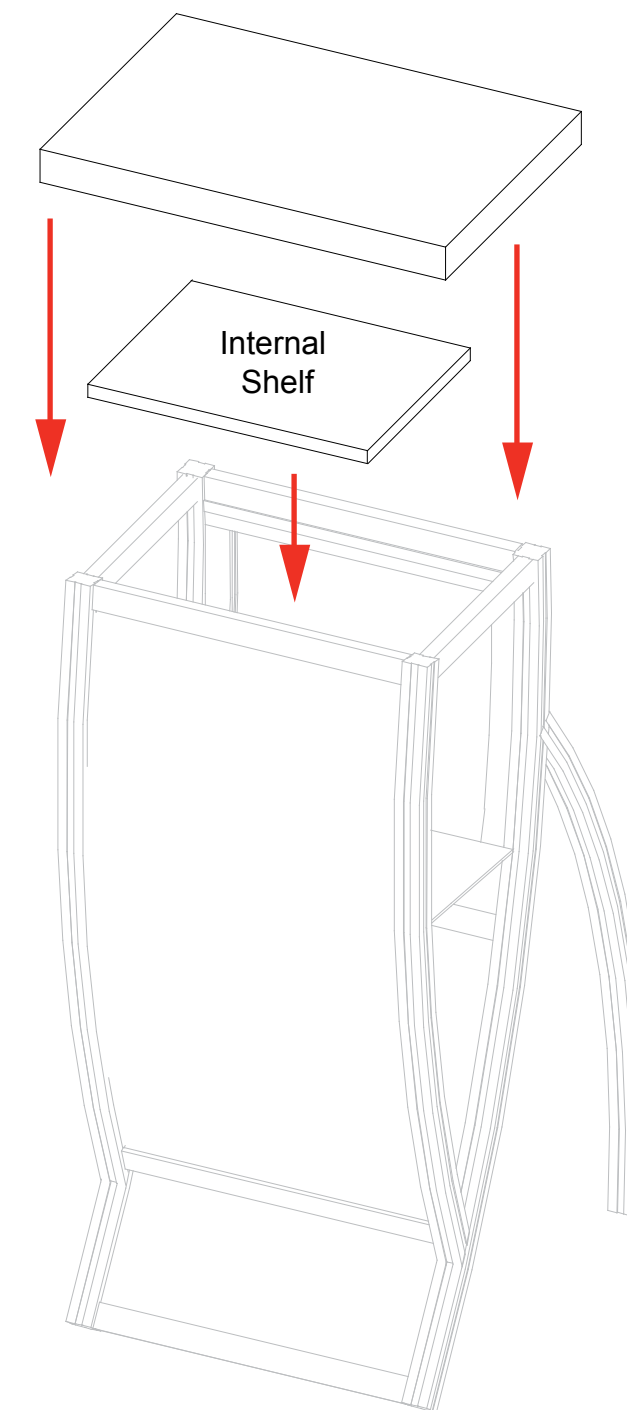

WHEN DISASSEMBLING TIGHTEN ALL KNOBS TO PREVENT LOSS DURING SHIPPING

Top View of Each Level

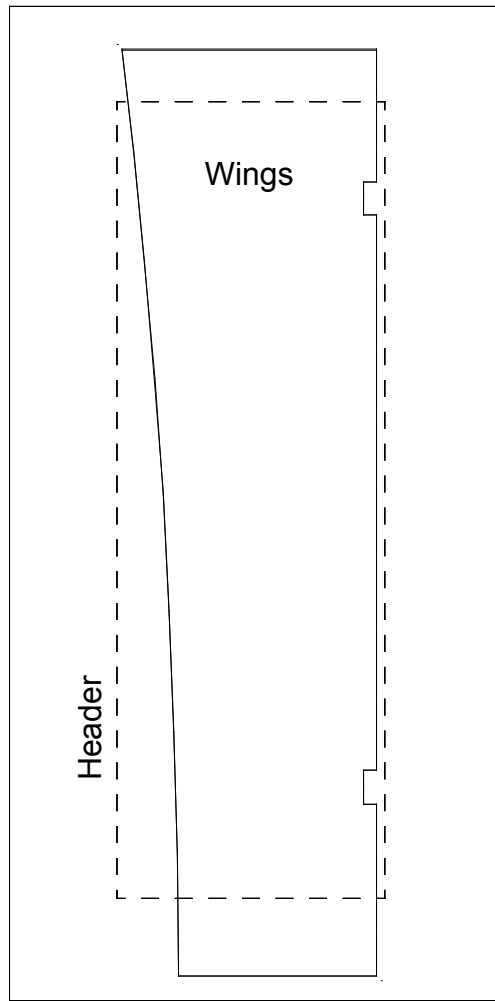

Level 1

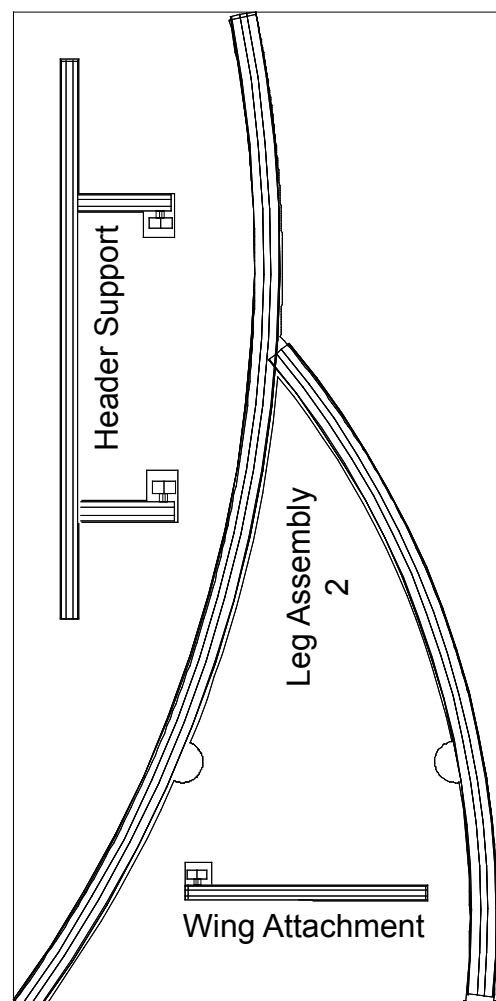

Level 2

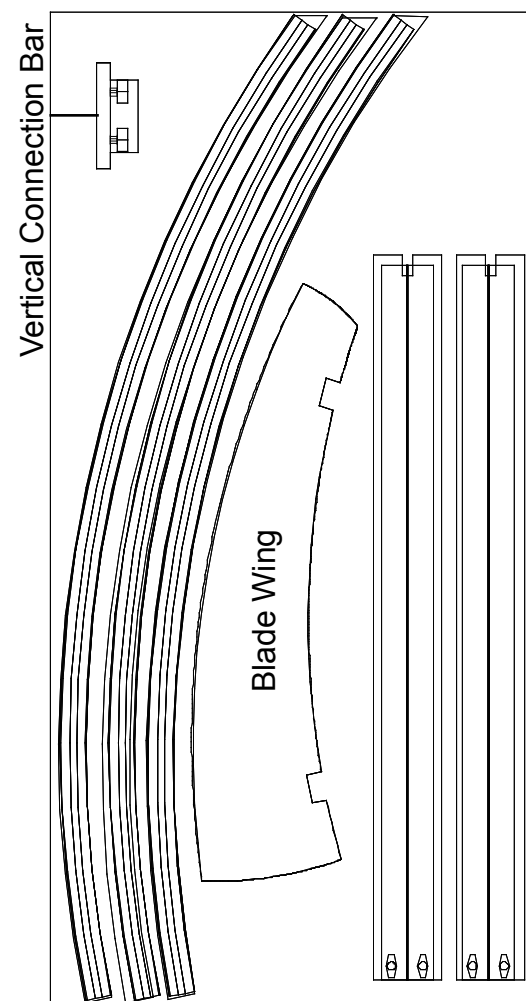

Level 3

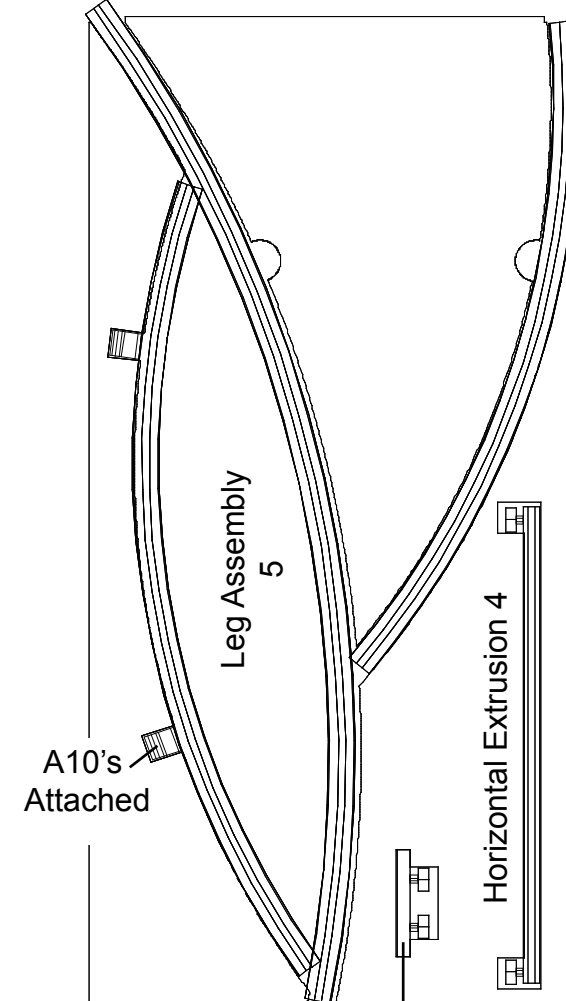

Level 4

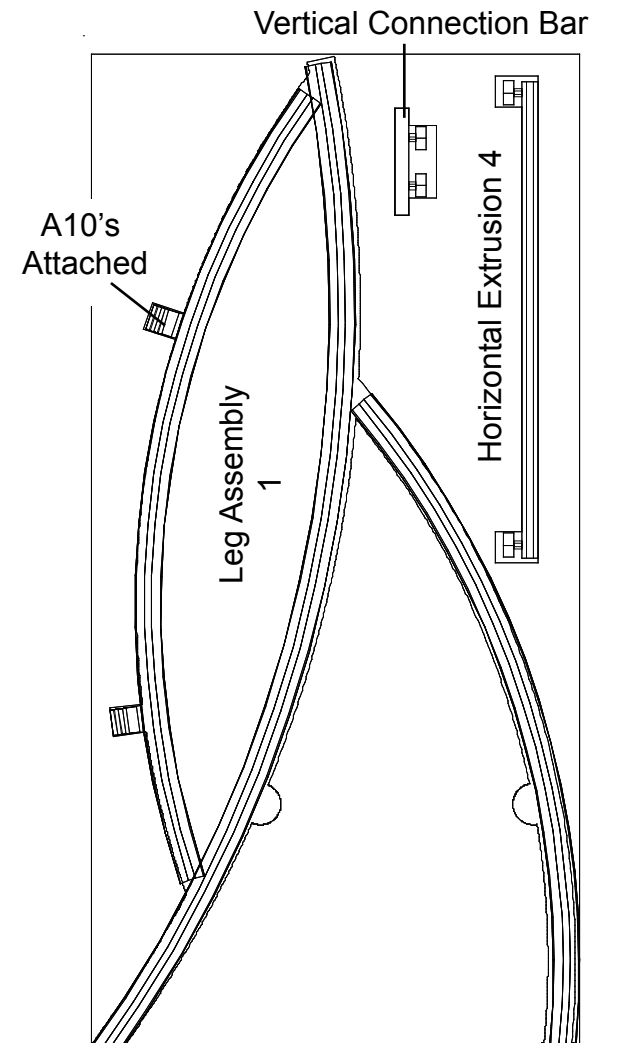

Level 5

- Additional Items:**
- Setup Hardware
 - Graphic
 - (3) Lights

WHEN DISASSEMBLING TIGHTEN ALL KNOBS TO PREVENT LOSS DURING SHIPPING

Top View

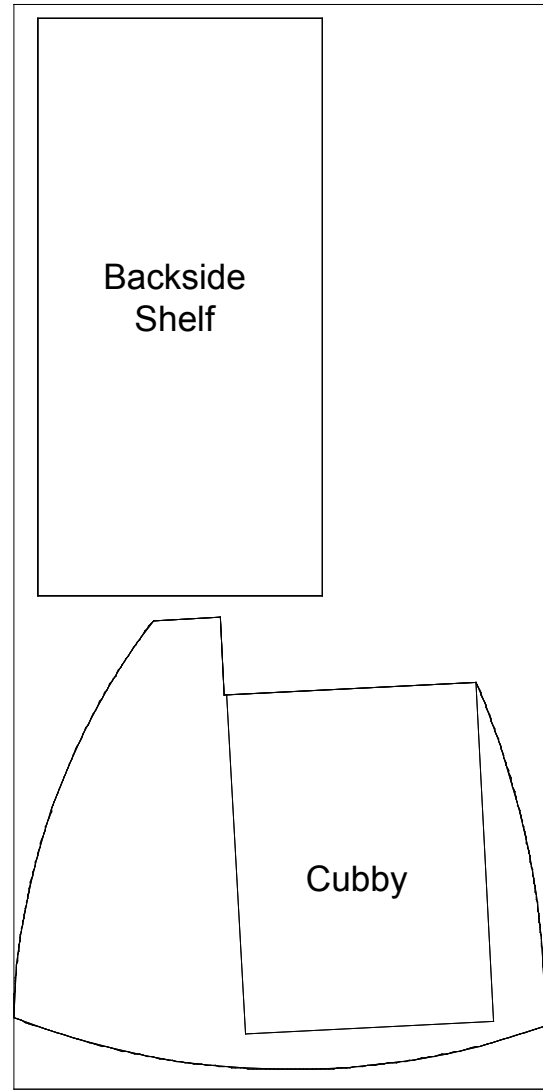

Level 1

WHEN DISASSEMBLING TIGHTEN ALL KNOBS TO PREVENT LOSS DURING SHIPPING

Top View of Each Level

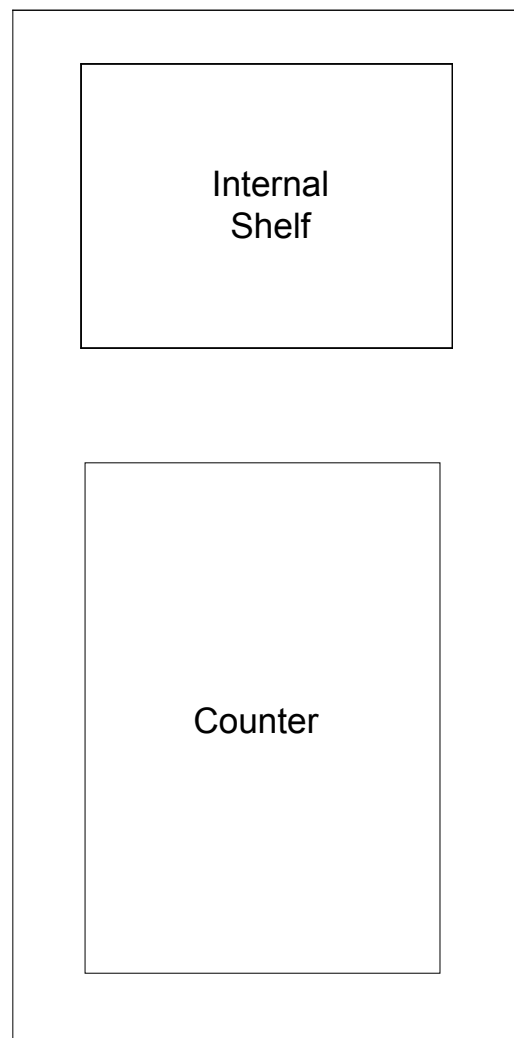

Level 1

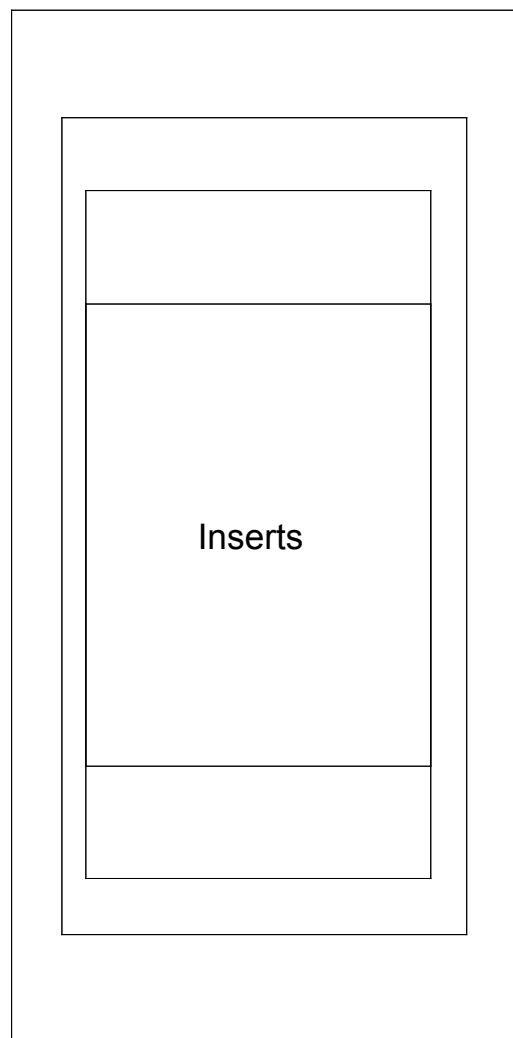

Level 2

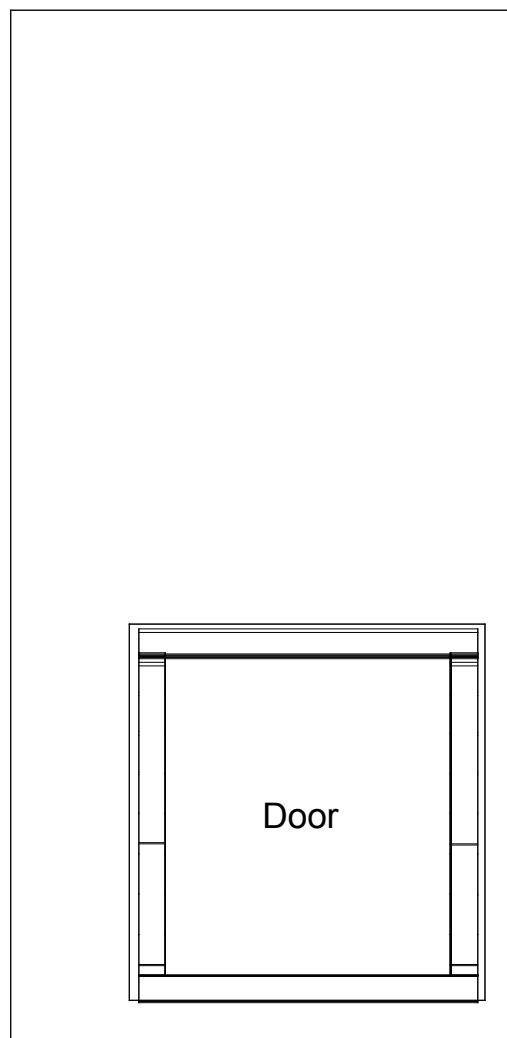

Level 3

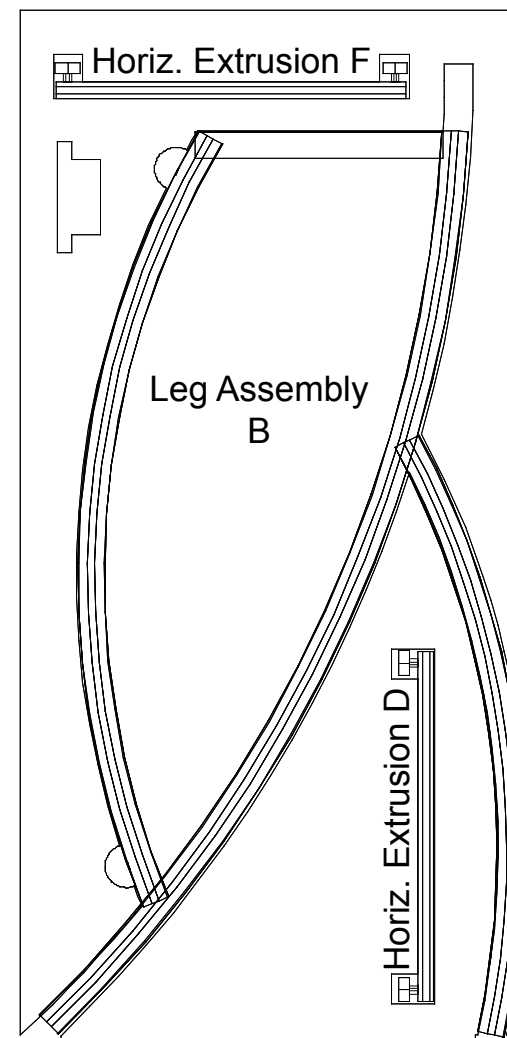

Level 4

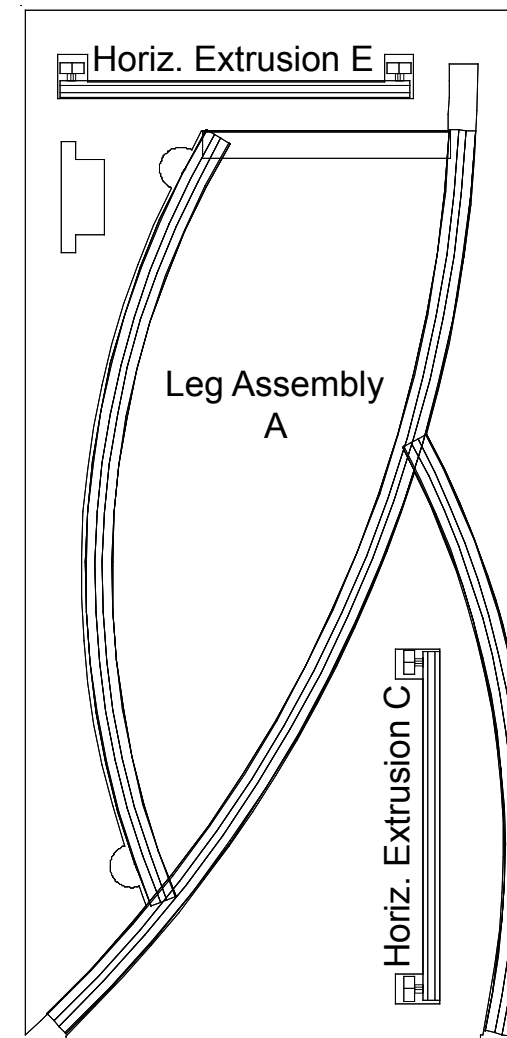

Level 5

WHEN DISASSEMBLING TIGHTEN ALL KNOBS TO PREVENT LOSS DURING SHIPPING